



## ТРУБЫ

Артикул	Наименование товара	Фото	DN	Максимальное давление	Толщина стенок	Цена розничная тенге
000161	PVC Труба		20	16 (bar)	2,0 мм	440
000162			25	16 (bar)	2,0 мм	550
000163			32	16 (bar)	2,4 мм	770
000164			40	10 (bar)	2,0 мм	935
000165			50	10 (bar)	2,4 мм	1100
000166			63	10 (bar)	3,0 мм	1595
000167			75	10 (bar)	3,6 мм	2640
000168			90	10 (bar)	4,3 мм	3520
000170			110	10 (bar)	4,8 мм	5280
000169			125	10 (bar)	4,8 мм	6160
000172			140	10 (bar)	5,4 мм	6930
000171			160	10 (bar)	7,6 мм	11660
000174			50	16 (bar)	7,0 мм	1650
A0014431			125	6 (bar)	3,1 мм	5390
A0014436			140	6 (bar)	5,0 мм	6160

## ВЕНТИЛЬ РАЗБОРНЫЙ

Артикул	Наименование товара	Фото	DN	Максимальное давление	Кол-во в коробке (шт)	Цена розничная тенге
000009	PVC Вентиль разборный		20	10 (bar)	120	2090
000010			25	10 (bar)	84	2420
000011			32	10 (bar)	36	3190
000012			40	10 (bar)	30	4070
000013			50	10 (bar)	24	4730
000014			63	10 (bar)	12	6380
000015			75	10 (bar)	2	10450
000016			90	10 (bar)	4	24090
000017			110	10 (bar)	2	32780

## КЛЕЙ И ОБЕЗЖИРИВАТЕЛЬ ДЛЯ ТРУБ

015237	Клей для PVC труб		125 мл	-	-	850
015238			250 мл	-	-	1400
015239			500 мл	-	-	2300
015240			1000 мл	-	-	4600
A0000136	Обезжириватель для PVC труб		240 мл	-	-	1000
A0000137			480 мл	-	-	1500
A0000138			960 мл	-	-	3000

## ЗАГЛУШКА

000020	PVC Заглушка		20	10 (bar)	950	55
000021			25	10 (bar)	500	110
000022			32	10 (bar)	320	170
000023			40	10 (bar)	180	220
000024			50	10 (bar)	130	280
000025			63	10 (bar)	165	385
000026			75	10 (bar)	96	600
000027			90	10 (bar)	80	990
000028			110	10 (bar)	48	1540
012657			125	10 (bar)	48	2090
012634			140	10 (bar)	20	2860
012658			160	10 (bar)	20	4180

Муфта								
000042	PVC Муфта		20	10 (bar)	600	85		
000043			25	10 (bar)	300	110		
000044			32	10 (bar)	256	165		
000045			40	10 (bar)	120	220		
000046			50	10 (bar)	72	330		
000047			63	10 (bar)	99	495		
000048			75	10 (bar)	72	990		
000049			90	10 (bar)	60	1650		
000051			110	10 (bar)	30	2200		
012659			125	10 (bar)	27	2970		
000050			140	10 (bar)	18	3410		
000052			160	10 (bar)	6	5830		
Отвод								
000063			PVC Отвод		20	10 (bar)	450	85
000064					25	10 (bar)	260	110
000065	32	10 (bar)			140	165		
000066	40	10 (bar)			63	330		
000067	50	10 (bar)			40	495		
000068	63	10 (bar)			75	825		
000069	75	10 (bar)			42	1760		
000070	90	10 (bar)			32	2970		
000071	110	10 (bar)			16	3960		
012632	125	10 (bar)			20	5280		
012633	140	10 (bar)			16	6160		
000072	160	10 (bar)			4	9460		
Полуотвод								
000074	PVC Полуотвод				20	10 (bar)	550	85
000075			25	10 (bar)	320	110		
000076			32	10 (bar)	168	140		
000077			40	10 (bar)	80	275		
000078			50	10 (bar)	48	440		
000079			63	10 (bar)	90	770		
000080			75	10 (bar)	40	1320		
000081			90	10 (bar)	32	2310		
000082			110	10 (bar)	24	3740		
012630			125	10 (bar)	24	4510		
012631			140	10 (bar)	16	5170		
000083			160	10 (bar)	6	8690		
Крестовина								
TK-00042649	PVC Крестовина прямая		50	10 (bar)	-	935		
TK-00042595			63	10 (bar)	-	1760		

### Тройник

000149	PVC Тройник		20	10 (bar)	280	110
000150			25	10 (bar)	150	165
000151			32	10 (bar)	88	220
000152			40	10 (bar)	40	440
000153			50	10 (bar)	24	825
000154			63	10 (bar)	50	1100
000155			75	10 (bar)	42	1650
000156			90	10 (bar)	32	3190
000157			110	10 (bar)	16	5060
012660			125	10 (bar)	18	6050
012661			140	10 (bar)	7	7260
006247			160	10 (bar)	4	11880

### Переход с Н.Р.

000086	PVC Переход с Н.Р.		20x1/2	10 (bar)	600	220
000088			25x3/4	10 (bar)	320	275
000090			32x1	10 (bar)	180	330
000092			40x1 1/4	10 (bar)	108	385
000094			50x1 1/2	10 (bar)	96	440
000096			63x2	10 (bar)	100	880
000097			75x2-1/2	10 (bar)	140	1100
000098			90x3	10 (bar)	54	1540
000100			110x4	10 (bar)	32	2090

### Переход кольцевой

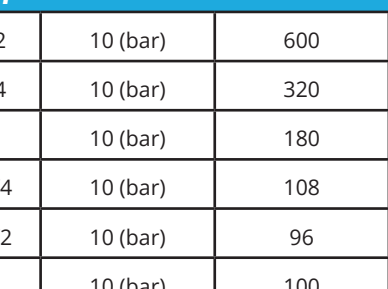
000101	PVC Переход кольцевой		25-20	10 (bar)	1200	40
000102			32-20	10 (bar)	630	55
000103			32-25	10 (bar)	630	85
004205			40-20	10 (bar)	420	110
000104			40-32	10 (bar)	350	140
004206			50-20	10 (bar)	250	165
000105			50-25	10 (bar)	180	220
000106			50-32	10 (bar)	180	275
000107			50-40	10 (bar)	180	330
000108			63-25	10 (bar)	180	305
000109			63-32	10 (bar)	180	330
000110			63-40	10 (bar)	180	355
000111			63-50	10 (bar)	150	385
000112			75-50	10 (bar)	140	605
000113			75-63	10 (bar)	100	660
000114			90-50	10 (bar)	100	825
000115			90-63	10 (bar)	100	935
000116			90-75	10 (bar)	100	1045
000117			110-63	10 (bar)	60	1540
000118			110-75	10 (bar)	60	1650
000119			110-90	10 (bar)	80	1760
006249			160-90	10 (bar)	24	3850
006250			160-110	10 (bar)	24	4070

**Переход с В.Р.**

000085	PVC Переход с В.Р.		20x1/2	10 (bar)	550	165
000087			25x3/4	10 (bar)	300	220
000089			32x1	10 (bar)	216	275
000091			40x1-1/4	10 (bar)	120	330
000093			50x1-1/2	10 (bar)	72	385
000095			63x2	10 (bar)	128	660
004244			75x2-1/2	10 (bar)	66	990
006248			90x3	10 (bar)	45	1430
000099			110x4	10 (bar)	42	1980

**ПЕРЕХОД МУФТОВЫЙ**

000120	PVC Переход муфтовый		25-20	10 (bar)	42	85
000121			32-20	10 (bar)	396	110
000122			32-25	10 (bar)	396	165
000123			40-20	10 (bar)	224	110
000124			40-25	10 (bar)	224	165
000125			40-32	10 (bar)	200	220
000126			50-20	10 (bar)	112	165
000127			50-25	10 (bar)	112	220
000128			50-32	10 (bar)	112	275
000129			50-40	10 (bar)	112	330
000130			63-25	10 (bar)	165	275
000131			63-32	10 (bar)	165	330
000132			63-40	10 (bar)	165	385
000133			63-50	10 (bar)	132	440
000134			75-40	10 (bar)	96	715
000135			75-50	10 (bar)	96	770
000136			75-63	10 (bar)	96	825
000139			90-40	10 (bar)	60	1045
000140			90-50	10 (bar)	60	1100
000141			90-63	10 (bar)	60	1210
000142			90-75	10 (bar)	60	1320
000143			110-50	10 (bar)	45	1430
000144			110-63	10 (bar)	45	1650
000145			110-75	10 (bar)	45	1870
000146			110-90	10 (bar)	45	2090
012662			125-110	10 (bar)	45	2420
012663			140-110	10 (bar)	12	2640
000147			160-110	10 (bar)	12	5280
012664			160-125	10 (bar)	12	5610
012665			160-140	10 (bar)	12	5940
000148	200-160	10 (bar)	6	9350		

**Муфта разъемная**

000054	PVC Муфта разъемная		1/2 (20)	10 (bar)	288	330
000055			3/4(25)	10 (bar)	240	385
000056			1(32)	10 (bar)	123	440
000057			1-1/4(40)	10 (bar)	72	770
000058			1-1/2(50)	10 (bar)	45	1320
000059			2(63)	10 (bar)	24	1760
000060			2-1/2 (75)	10 (bar)	16	2420
000061			3(90)	10 (bar)	12	3850
000062			4(110)	10 (bar)	8	6380

### Арматура для теплообменника Н.Р.

A0012311	PVC Арматура Н.Р.		50x1 1/2	10 (bar)	-	9900
A0012312			63x2	10 (bar)	-	14850

### Муфта разъемная резьбовая

A0000531	PVC Муфта разъемная резьбовая		32x1в.р.	10 (bar)	125	440
015989			50x1- 1/2в.р.	10 (bar)	45	1320
015969			63x2в.р	10 (bar)	24	1760

### Клапан ОБРАТНЫЙ УНИВЕРСАЛЬНЫЙ

006257	PVC Клапан обратный		20	10 (bar)	-	1980
006258			25	10 (bar)	-	2310
006259			32	10 (bar)	-	3080
006260			40	10 (bar)	-	3740
006261			50	10 (bar)	-	4400
006262			63	10 (bar)	-	5390
000035			75	10 (bar)	-	7590
000036			90	10 (bar)	-	10340
006251			110	10 (bar)	-	16280
006252			160	10 (bar)	-	28160

### Клапан обратный универсальный с резьбой

A0006781	PVC Клапан обратный		32x1	10 (bar)	-	3080
A0007144			50x1.1/2^ в.р.	10 (bar)	-	4400
A0007145			63x2^ в.р.	10 (bar)	-	5390

### Клапан обратный с прозрачной крышкой

007863	PVC Клапан обратный		50 V40-1E	10 (bar)	-	7590
007864			63 V50-1E	10 (bar)	-	9350

### Клапан обратный вертикальный

000029	PVC Клапан обратный		20	10 (bar)	54	1980
000030			25	10 (bar)	48	2310
000031			32	10 (bar)	66	3080
000032			40	10 (bar)	27	3740
000033			50	10 (bar)	15	4400
000034			63	10 (bar)	12	5390
018565			75	10 (bar)	12	7590
018566			90	10 (bar)	5	10340
A0007146			110	10 (bar)	3	16280

### Клапан обратный пружинный

TK-00042598	PVC Клапан обратный пружинный		40	10 (bar)	-	4950
015971			50	10 (bar)	54	5390
015970			63	10 (bar)	48	6380
A0016862			75	10 (bar)	6	10890
A0016863			90	10 (bar)	2	17490
0017083			110	10 (bar)	2	20790

### Затвор дисковый

006266	PVC Затвор дисковый		63	10 (bar)	16	8580
006267			75	10 (bar)	14	9460
006268			90	10 (bar)	10	12650
006269			110	10 (bar)	8	17820
006270			160	10 (bar)	4	28490

### ШТУЦЕР

015960	PVC Ершик		20x20	10 (bar)	480	220
015961			25x23	10 (bar)	300	220
015962			32x30	10 (bar)	200	280
015963			40x42	10 (bar)	120	280
015964			52x50	10 (bar)	66	330
A0007332			20x22 н.р. 1/2	10 (bar)	-	330
A0007142			25x27 н.р. 3/4	10 (bar)	-	440
A0007333			32x30 н.р. 1	10 (bar)	-	440
A0007147			40x42 н.р. 1.1/4	10 (bar)	-	550
A0007141			52x50 н.р. 1.1/2	10 (bar)	-	550

### Шланг

005745	PVC Шланг		20	10 (bar)	-	1760
A0000332			25	10 (bar)	-	1980
A0000333			32	10 (bar)	-	2040
A0000334			40	10 (bar)	-	2420
000180			50	10 (bar)	-	3140
015392			63	10 (bar)	-	4510

### Донный клапан

006263	PVC Донный клапан		40	10 (bar)	24	5280
006264			50	10 (bar)	24	5940
006265			63	10 (bar)	24	6490

### Фитинг для емкости внутренняя резьба

TK-00042764	Емкость фитинг для воды		15x1/2	10 (bar)	-	880
TK-00042765			20x3/4	10 (bar)	-	1430
TK-00042766			25x1	10 (bar)	-	1870
TK-00042767			32x1-1/4	10 (bar)	-	2750
TK-00042768			40x1-1/2	10 (bar)	-	3850
TK-00042769			50x2	10 (bar)	-	6050
TK-00042770			65x 2-1/2	10 (bar)	-	12100

### Фитинг для емкости наружная резьба

TK-00042596	Емкость фитинг для воды		20/25x3/4	10 (bar)	-	1100
TK-00042597			25/32x1	10 (bar)	-	1650
015965			32/40x1-1/4	10 (bar)	-	2200
015966			40/50x1-3/4	10 (bar)	-	3300
015967			50/63x2	10 (bar)	-	4400
A0002535			63/75x2-1/2	10 (bar)	-	7700

### Фланец

006253	PVC Фланец		50 "1 1/2"	10 (bar)	42	1540
006254			63 "2"	10 (bar)	36	1760
000176			75 "2 1/2"	10 (bar)	30	1980
000175			90"3"	10 (bar)	24	2640
000177			110 "4"	10 (bar)	24	5060
A0000565			125	10 (bar)	12	6380
017131			140	10 (bar)	12	8360
006255			160"6"	10 (bar)	8	11880

### PVC кран

006271	PVC кран белый		15 н/р	10 (bar)	-	990
--------	----------------	---	--------	----------	---	-----

### Трехходовой клапан

007866	PVC Трехходовой клапан		50	10 (bar)	-	7590
007865			63	10 (bar)	-	9350
TK-00041674	EMAUX FLEX40-3		50 x 63	5 (bar)	-	16390
TK-00041675	EMAUX FLEX50-3		63 x 75	5 (bar)	-	18590

### СЕРВОПРИВОД ДЛЯ ТРЕХХОДОВОГО КЛАПАНА

A0017296	FLEX Valve Actuator		<ul style="list-style-type: none"> <li>• Напряжение: 24 В переменного тока</li> <li>• Длина кабеля: 6 м</li> <li>• Предназначен для надежного управления 2- и 3-ходовыми перепускными клапанами для бассейнов, спа и водных объектов.</li> <li>• Автоматическая регулировка потока воды. Совместим с большинством систем автоматического управления бассейнами.</li> </ul>	61490
----------	---------------------	---	--	-------

### ВЕНТИЛЬ С ЭЛЕКТРОПРИВОДОМ

A0014485	PVC вентиль FOLS С Электроприводом		50	10 (bar)	-	98900
A0014486			63	10 (bar)	-	108900
A0014487			75	10 (bar)	-	162900
A0014488			90	10 (bar)	-	218900
A0014489			110	10 (bar)	-	246900
A0014490	Электропривод для затворов FOLS		50-80	10 (bar)	-	71900
A0014491			100-150	10 (bar)	-	104900

### КРЕПЛЕНИЯ ДЛЯ ТРУБ

006241	PVC Крепления		20	-	-	30
006242			25	-	-	40
006243			32	-	-	55
006244			40	-	-	85
000040			50	-	-	220
000041			63	-	-	385

**КОМПАНИЯ ОСТАВЛЯЕТ ЗА СОБОЙ ПРАВО ИЗМЕНЯТЬ ЦЕНЫ БЕЗ ПРЕДВАРИТЕЛЬНОГО УВЕДОМЛЕНИЯ**